

WeldFil Compact

Art. No.: 34 20

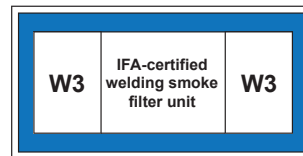
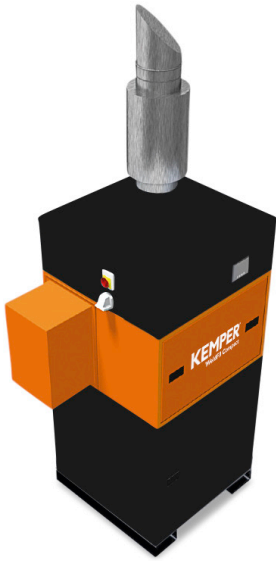

Applications

- High levels of smoke and dust
- Welding and grinding shops
- Training centres and robotic welding lines
- Laser, plasma and flame cutting systems
- Can be installed outdoors

Benefits

- Contamination-free dust collection due to compressed air fixation of dust collection containers
- Uninterrupted continuous operation due to automatic differential pressure-controlled filter cleaning
- Little noise emission due to a low noise level
- Quick and simple set up, delivered ready to plug in with forklift pockets and lifting eyes *1
- Considerable energy cost savings by using the automatic extraction volume control
- Flexible integration of the control system into third-party systems such as cutting equipment due to potential-free contacts *2
- Best health protection for employees by use of KemTex® ePTFE cartridges with surface filtration

Properties

- Automatic filter cleaning, pressure-controlled
- Control via touch screen
- W3/IFA certified
- KemTex® ePTFE filter cartridges
- Dust collection container with pneumatic lifting device
- Automatic extraction volume control (optional)

Accessories

- Automatic extraction volume control
- External On/Off
- Fleet management, remote maintenance and pre-noise maintenance using autarkic networking via mobile radio to the KEMPER cloud
- Spark separator – SparkTrap
- Weatherproof housing for outdoor installation

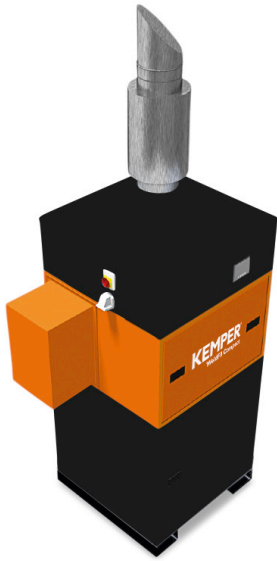

Technical Data

Filter

Filter stages	1
Filter method	Cleanable filter
Filter cleaning method	Rotating nozzle
Filter surface	10 m ²
Number filter elements	3
Filter surface total	30 m ²
Type of filter	Filter cartridge
Filter material	ePTFE membrane
Filter efficiency	> 99.99 %
Dust classification	M

Basic data

Extraction capacity	1250 - 2160 m ³ /h
Vacuum	2650 - 1950 Pa
Weight	410 kg
Motor power	3 kW
Power supply	3 x 400 V / 50 Hz
Rated current	6,5 A
Noise level	65 dB(A)

Additional information

Fan type	Impeller, direct driven
Compressed air supply	5 - 6 bar
Air outlet	250 mm
Air intake	250 mm
Capacity Dust collection container	34 l

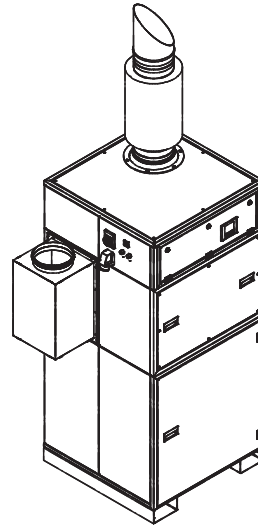
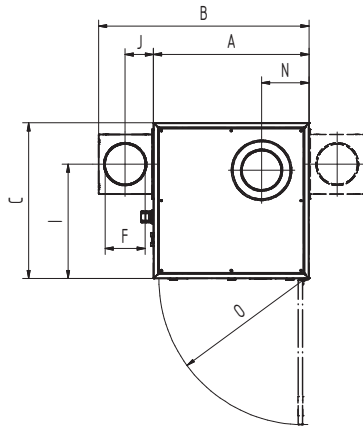
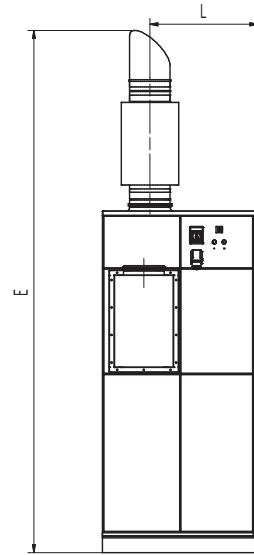
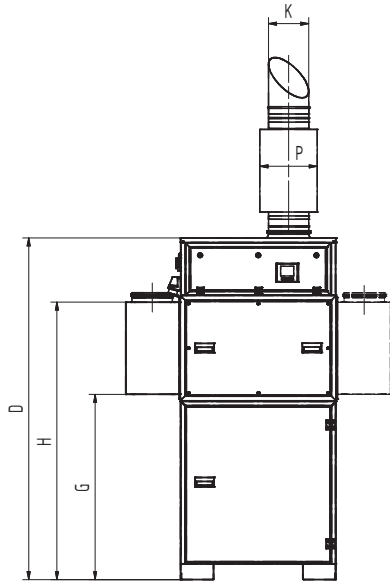

Technical Data

Dimensions

A	962 mm
B	1302 mm
C	962 mm
D	2110 mm
E	3230 mm
F	250 mm
G	1146 mm
H	1716 mm
I	706 mm
J	175 mm
K	250 mm
L	669 mm
N	293 mm
O	896 mm
P	355 mm

The shown transition pieces are optional

Pressure-volume graph

- Fan characteristic curve
- Working pressure increase
- ▨ Recommended Use

$$\frac{\Delta P_{s \text{ stat.}}}{Pa}$$

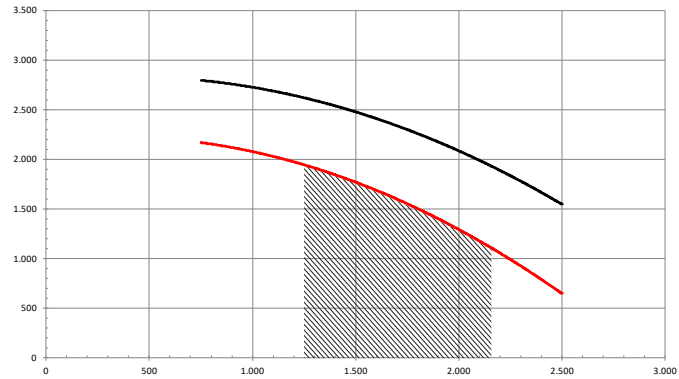

$$\vec{V} / m^3/h$$