

MaxiFil Clean

Art. No.: 67 250 100



Technical Data

Filter	
Filter method	Cleanable filter
Filter cleaning method	Rotating nozzle
Filter surface	15 m ²
Type of filter	Filter cartridge
Filter material	ePTFE membrane
Filter efficiency	> 99.9 %
Dust classification	M
Additional filters	Spark pre-separator made of aluminium mesh
Basic data	
Extraction capacity	1450 m ³ /h
Maximum vacuum	3300 Pa
Dimensions (w x t x h)	834 x 973 x 1350 mm
Weight	197 kg
Motor power	2.2 kW
Power supply	3 x 400 V / 50 Hz
Rated current	4.4 A
Control voltage	24 V, DC
Noise level	73 dB(A)
Additional information	
Fan type	Radial fan
Compressed air supply	5 - 6 bar
Quantity of extraction arms	1
Exhaust arm type	flexible exhaust arm
Diameter extraction arm	150 mm
Length of exhaust arm	2 m

Applications

- Suitable for all materials, including high-alloy steel
- High levels of smoke and particles
- Non-stop operation

Benefits

- Safe operation by rotation field control
- Exhaust arm requires less adjustment due to flow-optimised exhaust hood design
- Increased safety due to filter monitoring
- Very economic due to long lasting high capacity filters

Properties

- Automatic filter cleaning
- Exhaust arm up to 4 m
- Cleanable filter
- Rotating exhaust hood
- Easy to use: Intuitive & ergonomic one-button operation
- Disposal of welding fumes in disposable bags
- Spark pre-separator made of aluminium mesh

Accessories

- Automatic start-stop
- Workplace lighting incl. on/off switch at the hood



Suitable for alveole exchangeable dusts
separation > 99 % of particles < 0,4 µm



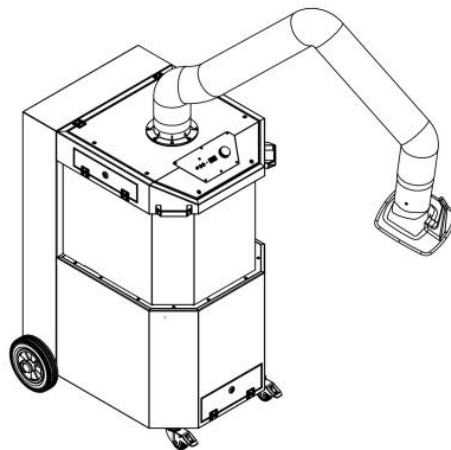
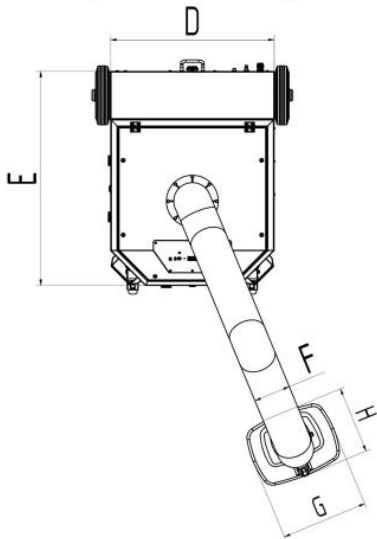
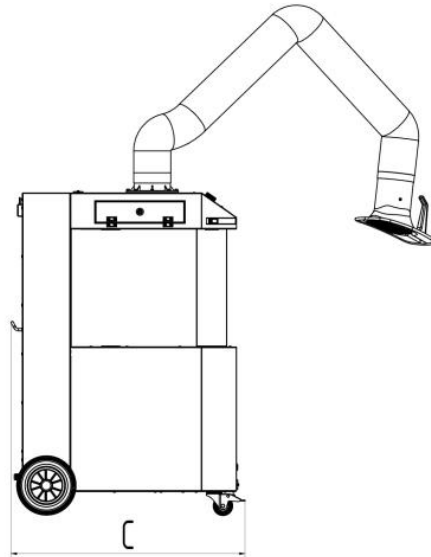
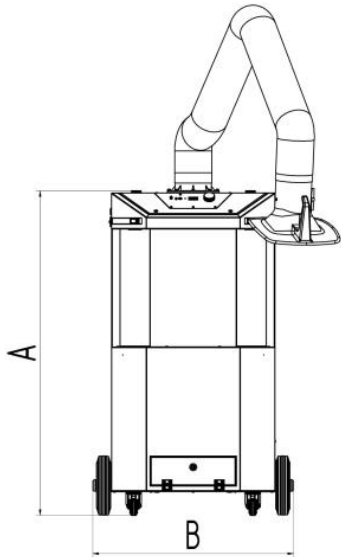

Technical Data

Dimensions

A	1350 mm
B	834 mm
C	973 mm
D	680 mm
E	890 mm
F	150 mm
G	360 mm
H	295 mm